

Kanthal® Global® SD

Silicon carbide heating elements

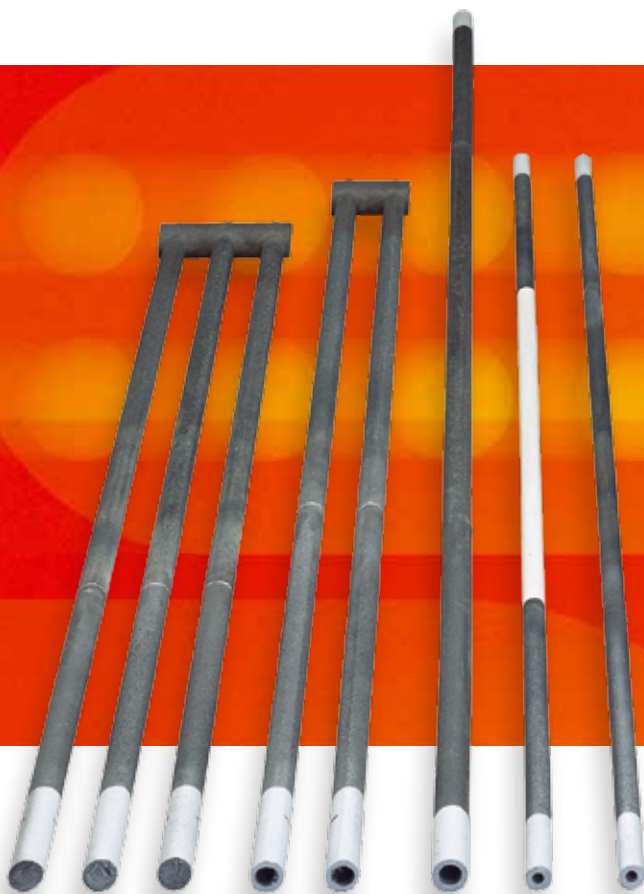

KANTHAL

Contents

Introduction	4
Product range	
Kanthal® Global® SD heating elements	5
Kanthal Global SD elements	5
Kanthal Global SD multi-leg elements	6
Applications	8
Installation methods	10
Kanthal Global SD rod element installation	10
Kanthal Global SD multi-leg element installation	11
Vertical mounting	11
Horizontal mounting	13
Element spacing – all element types	14
Electrical characteristics	14
Electrical specifications	15
Element performance	16
Element loading	16
Start up procedure	16
Operating temperature	16
Effect of atmosphere	18
Glazes and coatings	19
Continuous or intermittent operation	19
Power supplies	20
Element connections	20
Matching of resistance value	21
Voltage reserve	21
Power supply equipment	21
1 Variable output transformer	22
2 Thyristor (SCR) unit	23
2.1 Phase-angle firing	24
Power monitoring – phase-angle	25
2.2 Fast-cycle firing	26
Power monitoring – fast-cycle	27
3 Transformer + thyristor (SCR)	27
4 Direct-on-line	27
Ordering	29
Rod type elements	29
Multi-leg elements	29
Accessories	30

Introduction

FEATURES

- Can be used in applications ranging from 600°C up to 1600°C (1110–2910°F)
- Accepts significantly higher electrical loadings than metallic elements
- Considerable savings in furnace construction cost
- Maintenance is greatly simplified
- Available in multi-leg derivatives

Kanthal is the heating technology brand within Sandvik; the world's leading manufacturer of silicon carbide (SiC) heating elements.

Kanthal® Global® SD (SiC) elements are manufactured in recrystallized alpha silicon carbide, and have been designed to maximize performance in the widest range of high temperature equipment.

Kanthal Global SD elements are used in applications ranging in temperature from below 600°C (1110°F) up to 1600°C (2910°F) in both air and controlled atmospheres, although the type of atmosphere used will determine the maximum recommended element temperature.

Kanthal Global SD elements may be mounted either vertically or horizontally, and as the material remains rigid, even at the maximum operating temperatures, no special supports are required.

Kanthal Global SD elements will also accept significantly higher electrical loadings than metallic elements while maintaining superior performance in both continuous and intermittent heat processes. These factors can result in considerable savings in furnace construction costs and maintenance is greatly simplified. Elements can normally be replaced quickly, even when the furnace is hot, to minimize downtime.

Kanthal Global SD elements are available in the form of round section rods or tubes, in diameters from 10 mm–55 mm (0.39–2.17 in). Standard sizes are available to replace all previous ranges of Kanthal silicon carbide rod elements, such as Global LL, Silit ED and Kanthal hot rods and also in special sizes and resistances, to replace elements supplied by other manufacturers.

In addition to simple rod elements, Kanthal Global SD is available also in multi-leg derivatives, using 2, 3 or 4 legs, to allow all the electrical connections to be made at one end of the element, and simplify installation.

Product range

Kanthal® Globar® SD heating elements

Kanthal Globar SD elements

Kanthal Globar SD heating elements are made from high purity alpha silicon carbide grains, that are extruded in the form of rods or tubes, before being bonded together by a process of re crystallization, at temperatures of over 2500°C (4530°F). The firing process ensures the creation of rods with strong uniform bonds between adjacent grains, and the particle size distribution is closely controlled to ensure optimum density and resistance to the process atmosphere.

Kanthal Globar SD elements have the conventional central hot zone and two low resistivity cold ends. Elements with unequal cold end lengths can also be supplied if required.

Kanthal Globar SD elements can be supplied in 1-piece or 3-piece construction, according to the demands of the application. One-piece elements feature a joint free construction, where the cold

ends are formed by filling the pore structure with a low resistivity silicon alloy. 3-piece elements feature special low resistance cold ends that are joined to the hot zone using a reliable and strong reaction-bonding technique.

As the resistivity of the hot zone material is considerably higher than that of the cold ends, the majority of the heat is generated in the hot zone, when power is applied. The cold ends, which pass through the furnace lining, remain relatively cool, and are sprayed over a short length at the end with aluminum, to form a low resistance contact for the aluminum terminal braids.

Standard elements are available in a range of diameters between 10 and 55 mm (3/8 and 2 1/8 in) as detailed in Fig. 1. All of the elements are tubular, apart from 10 mm (3/8 in) diameter elements, which are manufactured in the form of solid rods.

Standard dimensions for Kanthal Globar SD elements

ØA, mm	10	12	14	16	20	25	32	38	45	55
B max.	350	500	600	600	850	850	1250	1450	2400	2400
L max.	650	950	1000	1150	1450	1600	2000	2250	3300	3300

ØA, in	3/8	1/2	9/16	5/8	3/4	1	1 1/4	1 1/2	1 3/4	2 1/8
B max.	13.8	19.7	23.6	23.6	33.5	33.5	49.2	57.1	94.5	94.5
L max.	25.6	37.4	39.4	45.3	57.1	62.3	78.7	88.6	129.9	129.9

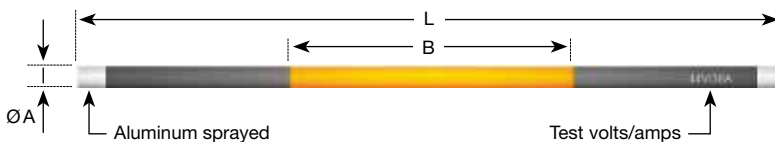

Fig. 1 Standard dimensions for Kanthal Globar SD elements.

Kanthal Global SD multi-leg elements

Kanthal Global SD multi-leg elements are manufactured from 2, 3 or 4 silicon carbide legs of exactly the same material and manufacture as standard Kanthal Global SD elements, each leg being divided into two clearly defined lengths of hot zone and cold end. All legs in any one element are matched in resistance value, to ensure that the load is evenly distributed, and are joined using silicon carbide bridges in a special process, which bonds the components into a monolithic structure of alpha silicon carbide. There are no jointing cements or welds which might limit the temperature capabilities of the finished element. The connecting bridges do not form part of the hot zone and can be used as end supports if required.

The type U element, manufactured from 2 legs, is a single-phase unit, although groups of elements may be connected to form a balanced 3-phase load.

The type CU is similar to the type U, but has a shortened bridge for applications where only limited space is available.

The type W element, with 3 legs, forms an effective star connected 3-phase element.

The type M element, with 4-legs, can replace two type U elements, reducing the number of terminal connections, and holes through the furnace lining. The 4 legs may have identical heated lengths, or the inner pair may have shorter or longer hot zones than the outer, to provide non-uniform heat distribution, where required.

Note that the bridge depth 'ØF' is not included in the hot zone length. Full details of preferred sizes and resistance values may be obtained from the element size list, and non-standard elements will also be considered on request. Elements having non-standard leg center distances (D) and support slot positions (E), to match competitor's multi-leg elements, can be supplied if required.

Standard dimensions for Kanthal Global SD multi-leg elements

ØA	mm	in	mm	in	mm	in	mm	in	mm	in	mm	in	mm	in
	16	5/8	20	3/4	20	3/4	25	1	32	1 1/4	38	1 1/2	45	1 3/4
B max.	500	19.7	800	31.5	800	31.5	850	33.5	1400	55.1	1400	55.1	1400	55.1
C max.	400	15.7	500	19.7	500	19.7	550	21.7	625	24.6	625	24.6	625	24.6
D	35	1.38	38	1.50	52	2.05	52	2.05	64	2.52	89	3.50	108	4.25
E	45	1.77	45	1.77	45	1.77	45	1.77	45	1.77	75	2.95	75	2.95
ØF	25	0.98	32	1.26	32	1.26	38	1.50	44	1.73	54	2.13	54	2.13
G (U)	60	2.36	65	2.56	79	3.11	87	3.43	102	4.02	145	5.71	165	6.50
G (CU)	35	1.38	38	1.50	52	2.05	52	2.05	64	2.52	89	3.50	108	4.25
G (W)	95	3.74	106	4.17	134	5.28	139	5.47	166	6.54	234	9.21	273	10.7

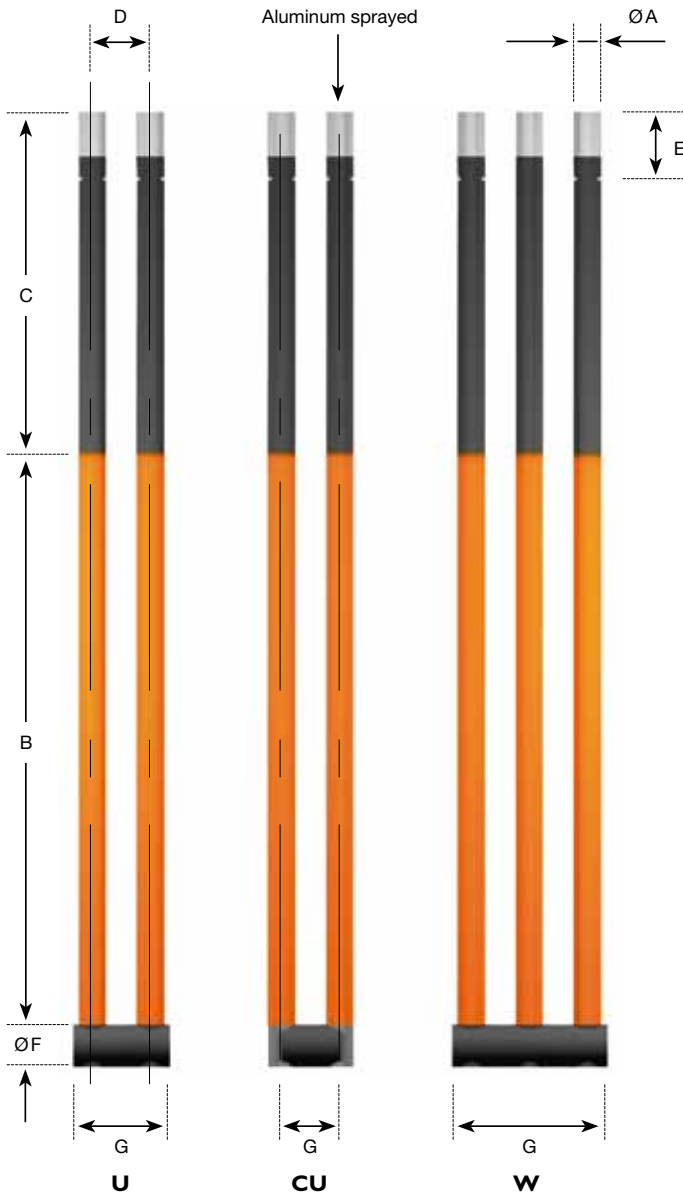

M
Special order only

Fig. 2 Standard dimensions for Kanthal Globar SD multi-leg elements.

Applications

All Kanthal Global SD rod and multi-leg elements may be mounted vertically or horizontally as shown in Fig. 3. The single ended connection of multi-leg elements makes them ideally suited to various applications where standard Kanthal Global SD rod elements cannot conveniently be used, such as where access would be difficult, where the furnace span is too wide to allow conventional elements to be fit, or in any case where single ended connections are essential.

Kanthal Global SD elements are used in a wide variety of furnace applications, from small laboratory furnaces to large industrial heating processes, in different atmospheres and temperature ranges. The elements allow great freedom in furnace design which, combined with simple installation and long operating life, makes them the preferred choice in many applications including: glass, ceramics, electronics and metal industries, and also for research and development. Examples of some typical furnaces where Kanthal Global SD elements are the natural choice are illustrated below.

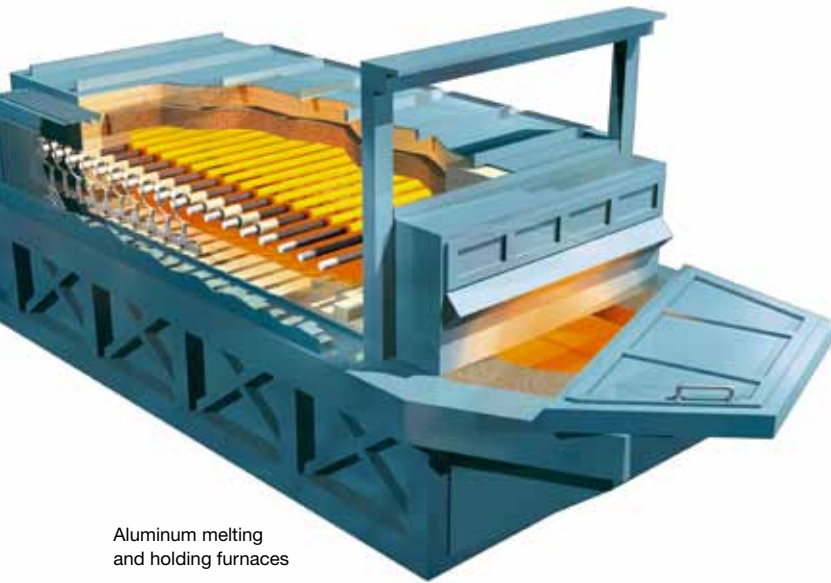

Aluminum melting and holding furnaces

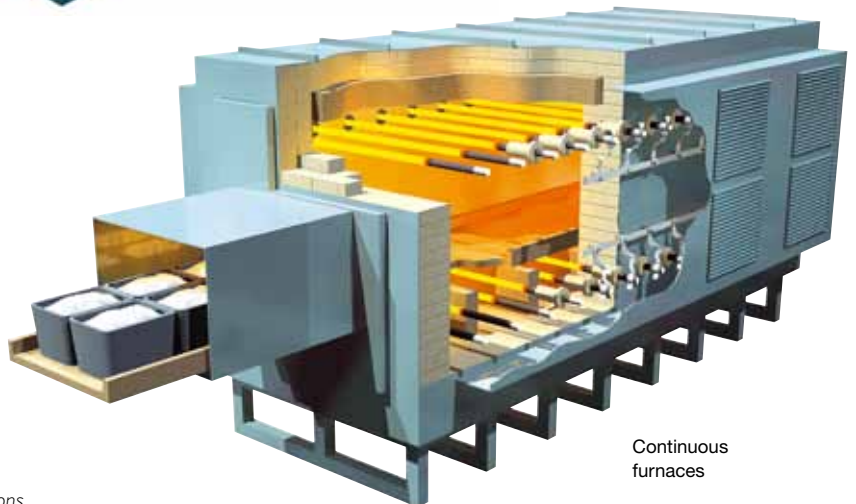

Continuous furnaces

Fig. 3 Typical furnace applications.

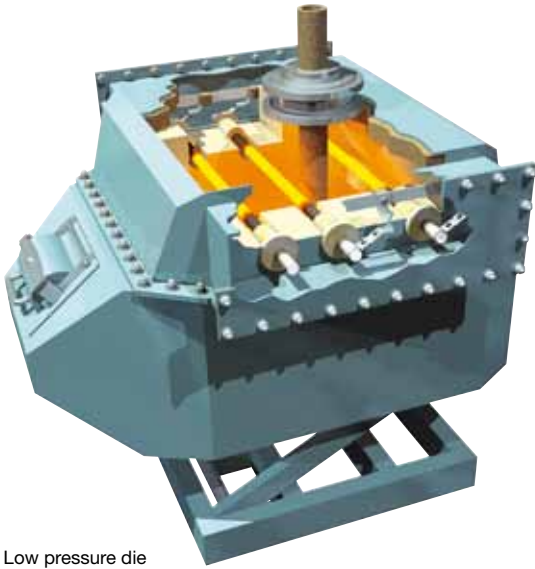

Low pressure die casting furnaces

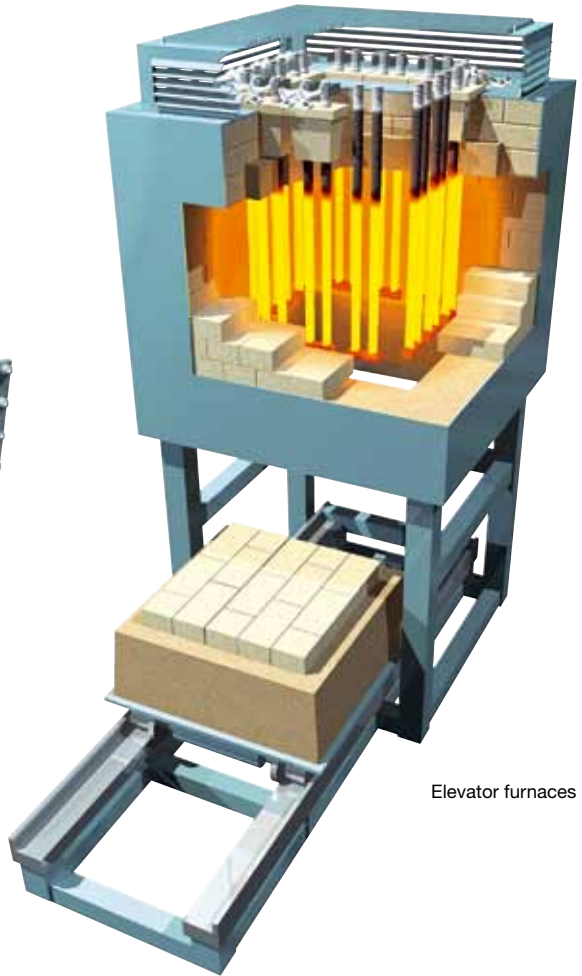

Elevator furnaces



Rotary hearth furnaces

Installation methods

Kanthal Globar SD rod element installation

Although silicon carbide is rigid and self supporting, it has a fairly low impact strength, and care must be taken when unpacking and handling the elements so that they are not subjected to mechanical shock. Elements should always be supported in two hands.

It is important to ensure that the elements are not restricted in any way and are free to move radially, as well as axially, in their support holes. Element holes must be in line, and the whole alignment should be checked by passing a straight bar, of the same diameter as the support holes, right through the furnace, before fitting the elements.

Under no circumstances should the element hot zones be allowed to enter the element support holes as this will lead to localized overheating and premature failure.

Special lead-in sleeves are available for mounting all diameters of Kanthal Globar SD elements and these are detailed in Fig. 4 and in the accessories size list. Sleeves should be fit from the outside of the furnace, in holes bored to a diameter that will ensure a loose fit, and the sleeves should never be cemented into position. In general, the sleeves will be far shorter than the thickness of the furnace

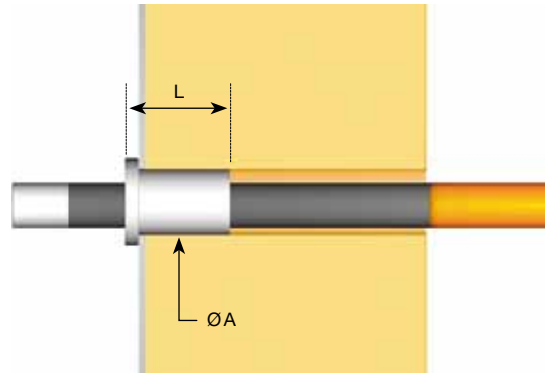

Fig. 4 Standard sleeve patterns and installation.

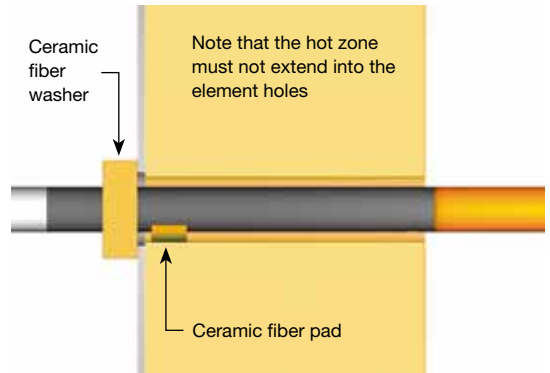

Fig. 5 Installation without sleeves.

Pattern standard dimensions

Pattern	Ø element		Ø A		L	
	mm	in	mm	in	mm	in
SL10	10	3/8	18	0.71	75	2.95
SL14	12 & 14	1/2 & 5/9	26	1.02	75	2.95
SL20	16 & 20	5/8 & 3/4	31	1.22	75	2.95
SL29	25	1	43	1.69	75	2.95
SL32	32	1 1/4	47	1.85	75	2.95
SL38	38	1 1/2	56	2.20	75	2.95
SL45	45	1 3/4	62	2.44	75	2.95
SL55	55	2 1/8	70	2.76	150	5.91

insulation, but the clearance holes should be drilled right through to the hot face, as shown in Fig. 4, to prevent any contact between the elements and the lining, as this can lead to adhesion, and premature failure.

If sleeves are not to be used, for example in brick-lined furnaces, then the elements may be fit through holes about 4–5 mm (1/6–1/5 in) larger than the element diameter for element sizes up to 20 mm (3/4 in), and about 8–10 mm (1/3 in) larger for elements from 25–55 mm (1–2 1/8 in) diameter. Even larger holes may be required where there is a possibility of volatiles condensing in the element holes or on to the cold ends, or where the furnace lining is exceptionally thick.

Elements should always be centralized by supporting each cold end on a small pad of ceramic material, to prevent contact between the element cold ends, and the lead-in holes. Under no circumstances should the cold ends be wrapped with ceramic fiber or other insulation, as this will lead to restriction and possible premature failure. To prevent radiation on to the terminal connections and minimize heat losses, a flexible ceramic fiber washer may be fit over each terminal end and positioned so that it rests against the outer face of the furnace (Fig. 5).

In all cases, the element ends should extend beyond the sleeve flange, or the outer face of the fiber washer, by a distance of approximately 2–3 times the element diameter.

The use of aluminum braid is recommended for making terminal connections as it does not suffer from progressive oxidation and is sufficiently flat and soft to allow a good connection to be made. Braids are normally attached using type H spring clips, which are easy to install and require no tools. Where space is restricted, type C clips may be used, and these require a special tool for installation. Both H and C clips rely on spring steel to maintain a good contact, and must be maintained at a temperature below about 250°C (480°F). For higher temperatures, types G and D clamps may be used. These are clamped to the elements using stainless steel set screws, and high temperature lubricant should be applied to the threads before installation, to prevent seizing, and later difficulty in tightening and removal. Screws should be retightened after 24 hours use.

Element connections must be kept reasonably cool and any terminal guards fit should be well ventilated. Where sealed terminal boxes are essential, for example in controlled atmosphere furnaces, then the following procedures should be followed:

- Increase the free length of cold end outside the furnace to 4–5 times the element diameter
- Ensure that the surface area of the terminal covers is sufficient to ensure adequate cooling. It may be necessary to provide finned covers to increase the surface area
- Use type D terminal clamps, and larger section connecting braids than normal
- Introduce a proportion of the process gas via the terminal boxes, to assist in cooling
- In very severe cases, some kind of forced cooling may be required

Where Kanthal Globar SD elements are to be mounted vertically, a support of electrically insulating, heat-resistant material should be provided below the terminal end. Alternatively, elements of 16 mm (5/8 in) diameter and above may be supplied to special order with support slots and washers to allow them to be suspended from the top of the furnace, in a similar manner to vertically mounted type U elements (Fig. 6).

Kanthal Globar SD multi-leg element installation

All multi-leg elements must be unpacked and handled with care, using both hands for support, and ensuring no stress is placed on the element legs. Any transit straps fit across the legs should be removed, just before installation.

Vertical mounting

Multi-leg elements are usually mounted vertically and suspended through pre-drilled refractory support blocks shaped to fit corresponding holes in the furnace roof. Elements and blocks may be pre-assembled and placed in position as required. The precise shape and size of the blocks will depend on the element dimensions and the construction of the furnace roof.

Elements are usually supported using specially designed support washers as detailed in Fig. 6, but may be supported on a suitable ceramic fit below the bridge, if required.

Precautions must be taken to prevent the terminals from overheating, especially if the elements are operating at the higher end of their temperature range or if the roof lining is relatively thin. In most cases a 25 mm (1 in) thick pad of ceramic fiber fit below the support washers will be sufficient, providing the terminal boxes are adequately ventilated. In more severe cases it may be necessary to mount the elements through a separate support plate, fit about 75–100 mm (3–4 in) above the furnace casing, to allow a free flow of air or process gas over the exposed cold ends. Alternatively, elements can be supplied with support slots or holes in a non-standard position, to allow for a greater free length of terminal.

Support blocks must be manufactured from a refractory material capable of withstanding the maximum element temperature (which may be considerably higher than the furnace temperature) and should have a sufficiently high electrical resistivity to prevent conduction between adjacent legs at that temperature. Generally, a high alumina, low

iron refractory or vacuum-formed ceramic fiber material will be most suitable.

It is essential to ensure that the element mounting holes are parallel, and accurately drilled at the correct center distance. The hole diameter should generally be about 6 mm (1/4 in) greater than that of the element legs for elements up to 20 mm (3/4 in) diameter, and 9 mm (1/3 in) greater for the larger sizes.

Sandvik supplies special LB ceramic fiber location blocks to fit the most common sizes of U and CU elements. It should be noted that the flange on the location blocks is not designed to carry the mass of the elements, and a separate hard, strong insulating board, cut with clearance holes for the element legs, must be fit above the flange, to transfer the load on to the furnace casing.

The LB location blocks are available in 3 different temperature ratings of 1250°C (2280°F), 1400°C (2550°F) and 1500°C (2730°F), which should

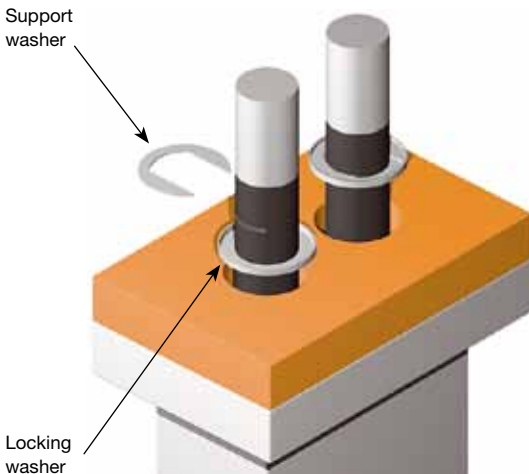
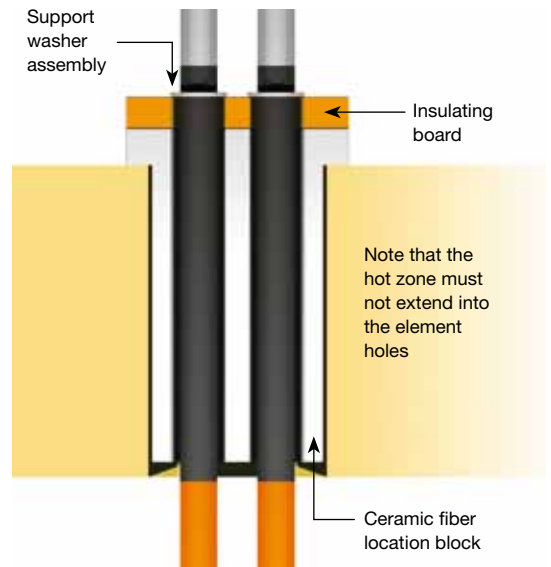

Fig. 6 Typical vertical installation.



correspond to the maximum expected element temperature.

Under no circumstances should the element hot zones be allowed to enter the element support holes as this will lead to localized overheating and premature failure.

Elements may also be mounted vertically with the terminals at the base and should be located on an electrically insulating, heat resistant support fit below the terminal end. Long elements supported in this way may need a stabilizing support or hook fit at the bridge end.

Type M elements have wider cold end spacings than the 2 and 3-legged elements, and it may be preferable to fit the elements from inside the furnace, using SL sleeves to isolate the cold ends for the lining and casing of the furnace.

Horizontal mounting

Special precautions are required where multi-leg elements are to be installed horizontally, especially with long elements, and the element cold ends must be supported on a hard smooth surface in such a way that they are free to move laterally during heating and cooling. An alumina tube, installed with its axis at 90° to the legs' axes is a suitable support. Holes through the furnace insulation should be in the form of slots, or clearance holes, so that the legs are supported only by the ceramic tube, and do not contact the insulation. Elements should never be cantilevered, and the bridge should always be supported. It is important to ensure that the bridge support is level, and co-planar with the ceramic tube supporting the element legs, otherwise one of the legs may not be fully supported and may fail prematurely.

As it is often impossible to ensure that the supports are exactly in line, self-aligning systems have been developed by Kanthal, and special elements can be supplied with a pivot pin attached to the bridge, to allow it to rotate freely and prevent mechanical stressing of the legs. Alternatively, standard element bridges can be supported on a length of alumina tube, which will allow free rotation of the bridge, relative to the element legs (Fig. 7).

Horizontal elements should generally be installed with the legs in the same horizontal plane. Installation with leg centers in the same vertical plane is possible only with short elements, and is not generally recommended, due to difficulty in ensuring that both legs are equally supported.

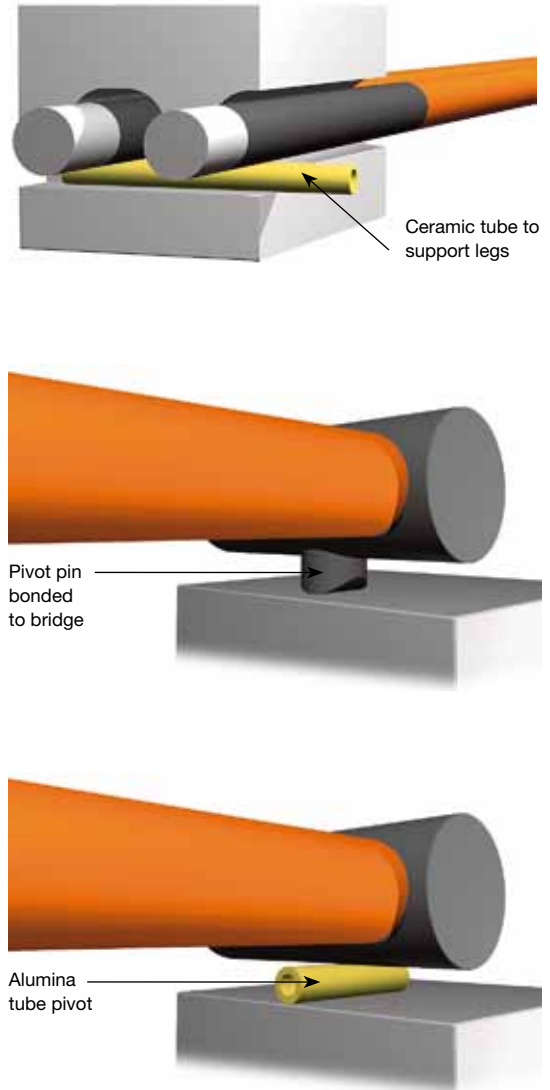

Fig. 7 Typical horizontal installation methods.

Element spacing – all element types

Elements should be spaced at a minimum of 2 diameters between centers, but 2.5–3 times the diameter is preferred. There should be 1½ diameters between element centers and the refractory lining, and a distance of at least 2 diameters should be allowed between the element centers and the products being fired. It may be necessary to increase this if uniformity of heating is required, especially if the distance between adjacent elements is large (Fig. 8). Where multi-leg elements are being used, it is advisable to increase the minimum clearance between elements slightly, to ensure at least 15 mm (5/8 in) clearance between adjacent bridges.

Electrical characteristics

Kanthal silicon carbide elements have a much higher resistivity than metallic elements and can be operated at higher surface loadings (i.e. W/cm² (W/in²) of the hot zone surface area).

The resistivity/temperature characteristic is shown in Fig. 9.

Kanthal Globar SD elements have a high and variable resistivity at room temperature, but this falls with increasing temperature, reaching a minimum at about 700°C (1290°F). At element temperatures above 700°C (1290°F), resistivity increases with rising temperature.

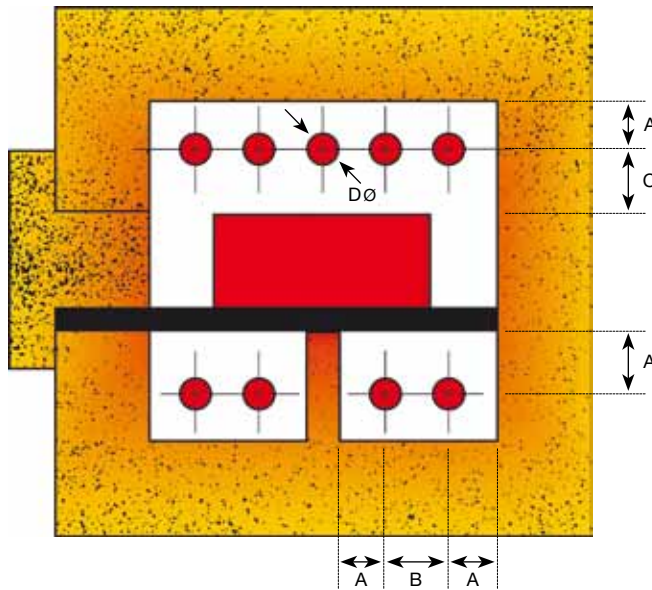

- A = (1.5 × D) = Minimum spacing between element center and any adjacent refractory
- B = (2 × D) = Minimum spacing between adjacent element centers
- C = (2 × D) = Minimum spacing between element centers and hearth plates or work
- D = Element diameter

Note:

If under hearth heating is to be used then the hearth plates should be as thin as possible and have a thermal conductivity of at least 14 W/mK.

It may be necessary to limit the power output to prevent overheating.

Fig. 8 Recommended element spacings.

Minute variations in the quantities of minor impurities in the material have a disproportionate effect on the cold resistance value, as indicated by the dotted curves, and room temperature resistance measurements give no indication of the resistance at working temperature.

Resistance measurements should always be carried out at a constant temperature at or above 1000°C (1830°F), and the value determined by dividing the voltage across each element by the current passing through it.

Electrical specifications

The nominal resistance values detailed in the element size lists are based on an element temperature of 1000°C (1830°F), as illustrated in Fig. 9. The resistance values are subject to a tolerance of ±15% and although the nominal value is generally used when calculating the voltage range of the power

supply, the negative resistance tolerance must be considered when calculating the maximum current drawn (see page 22).

Kanthal Globar SD elements are marked with a standard test voltage, calculated to raise an element of nominal resistance to a temperature of 1000°C (1830°F) in free air. The test current value at this voltage is also marked on each element, and should be used when matching element resistances. The test voltage is for calibration purposes only, and the maximum recommended voltage with new elements will not normally exceed 80% of the test voltage.

The size lists detail the range of preferred element sizes, but non-standard elements, including Kanthal Globar SD elements with offset hot zones, can also be supplied.

Resistivity/temperature characteristic curve

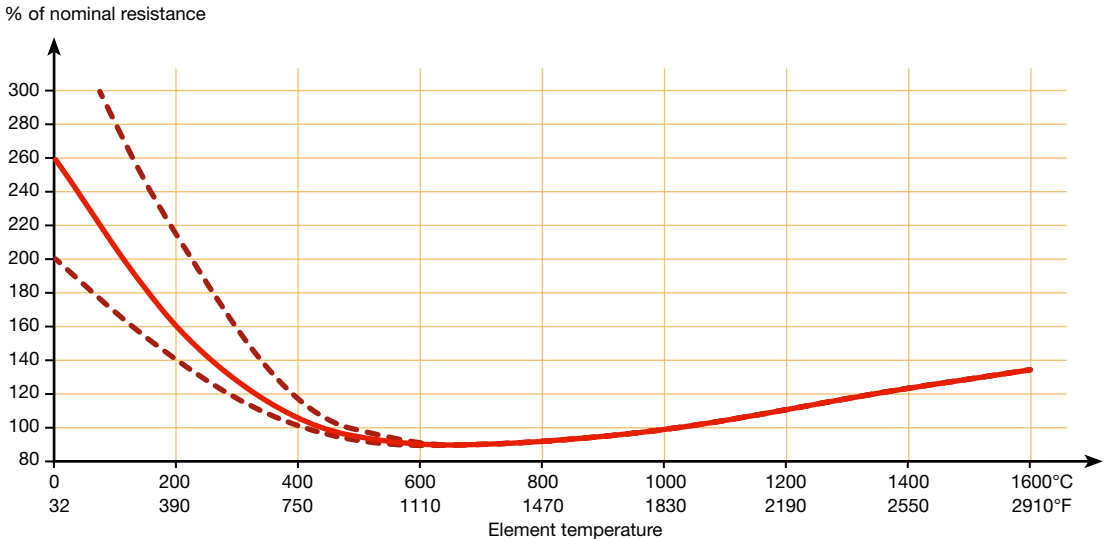

Fig. 9 Typical R/T curve.

Element performance

All silicon carbide elements increase in resistance during their life in operation, and the rate at which this occurs is affected by the following factors:

- Furnace temperature
- Element surface loading in W/cm² (W/in²)
- Atmosphere surrounding the elements
- Mode of operation – continuous or intermittent
- Operating practices and power control methods used

As a general guide, Kanthal Globar SD elements may increase in resistance at a rate of about 5–6% per 1000 hours operating continuously in clean air at a temperature of 1400°C (2550°F) and at about 3% per 1000 hours use at 1000°C (1830°F). It should be noted that small changes in operating conditions can alter these rates considerably.

Element loading

Silicon carbide elements do not have a specific rating in watts, and the rated power is a function of the required temperature, the atmosphere in which the elements will be used, and the operating cycle. Expressed in W/cm² (W/in²), the surface loading is derived by dividing the power from each element, by the surface area of the hot zone section, which is detailed in the element size lists, or can be calculated by:

$$\pi \times D \times L,$$

where D is the outer diameter of the element in cm (in), and L is the hot zone length in cm (in).

As the element temperature is directly proportional to the surface loading applied, the lowest power loading consistent with the furnace design should be used for optimum element life, and this is usually in the range 3–8 W/cm² (19–52 W/in²).

Fig. 10 illustrates the relationship between furnace temperature, element surface loading and element temperature.

For example:

At a furnace temperature of 1400°C (2550°F) and an element loading of 5 W/cm² (32 W/in²) the element temperature would be 1450°C (2640°F), as

indicated by the red line. At a furnace temperature of 1100°C (2010°F) and a loading of 6 W/cm² (39 W/in²) the element temperature would be about 1200°C (2190°F) as indicated by the brown line.

The curve shows maximum recommended element loadings for elements operating in air. These values may be used as a guide, but for maximum element life a lower loading should be used wherever possible. A lower loading may also be required where elements are to be operated in reducing or other process atmospheres, to maintain element temperatures within the limits detailed in the table, page 18. The minimum recommended surface loading is 3 W/cm² (19 W/in²), although lower values are possible, where the power supply has sufficient voltage available to overcome the high cold resistance of the elements.

Start up procedure

Rapid heating is detrimental to all ceramic materials, and although Kanthal Globar SD and multi-leg elements are particularly resistant to thermal shock, care must be taken when heating up from cold to limit the applied voltage, and hence the element heating rate. The test voltage marked on every element must never be exceeded, but in general, it will be beneficial to limit the applied voltage to a lower value, calculated from the element design power, and the nominal element resistance:

$$V = \sqrt{WR}$$

Where W is the design power of the element in watts, and R is the nominal element resistance.

Operating temperature

Kanthal Globar SD elements may be used in air at furnace temperatures up to maximum of 1600°C (2910°F), but the use of other atmospheres may reduce this limit considerably. There is no lower limit to the operating temperature of the equipment, but the element surface loading should be set to achieve an element temperature of at least 900°C (1650°F).

Recommended element loadings for Kanthal Globar SD operated in air

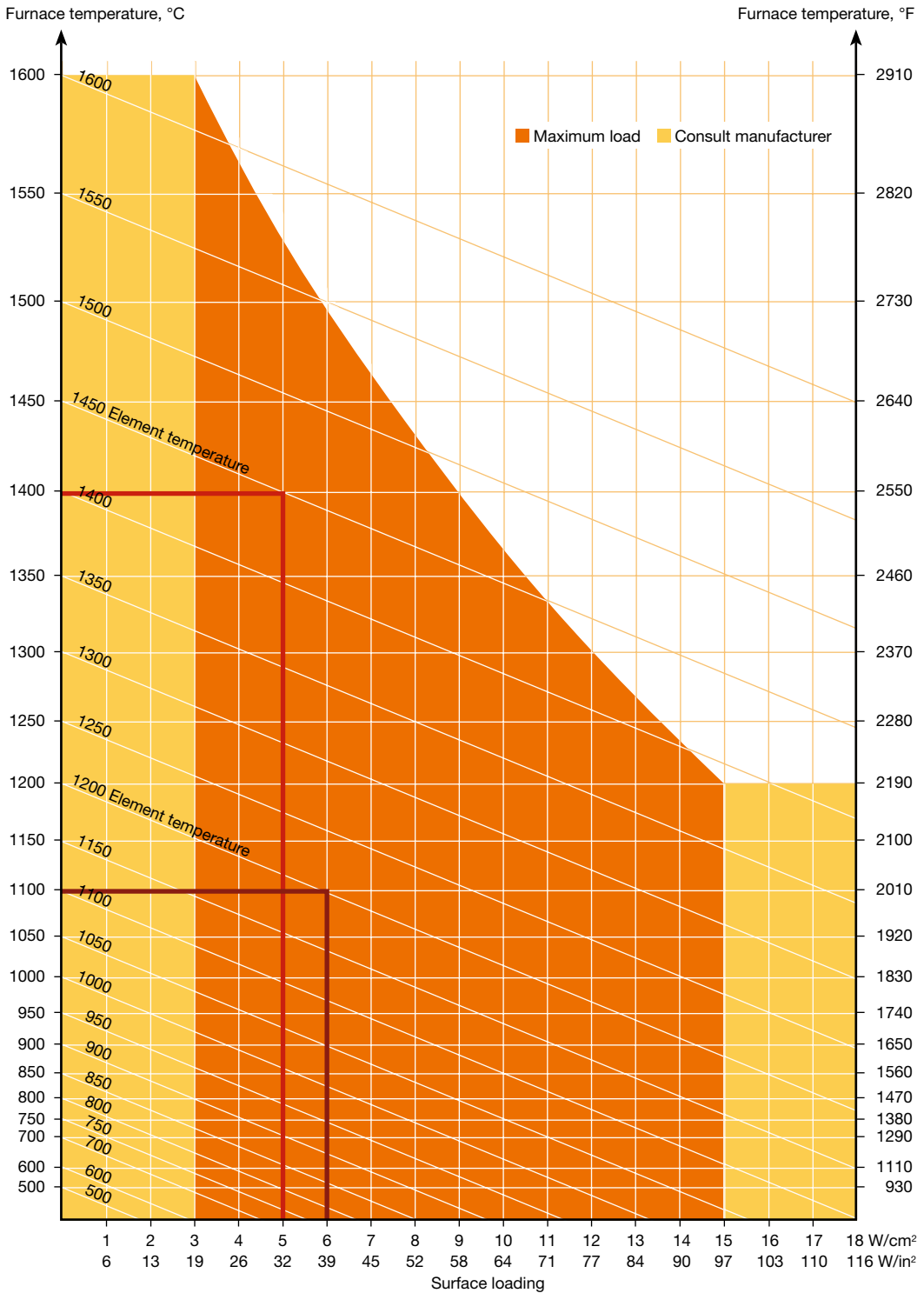

Fig. 10 Surface loading chart.

Effect of atmospheres

Although clean, dry air is the preferred atmosphere in which to use Kanthal Globar SD elements, many other process gases may be used. Silicon carbide oxidizes readily in air, but the product of oxidation, silicon dioxide, forms a stable amorphous silica film over the silicon carbide grains, thus retarding the later rate of oxidation, which is limited by diffusion of oxygen through the silica layer. This passive oxidation requires a free oxygen content of at least 1%, and at lower oxygen levels, active oxidation may occur due to the inability to form a stable silica film.

Active oxidation also occurs in water vapor, as the silica formed is likely to be crystalline and non-protective. Elements exposed to water vapor, even for a short period of time, will be seriously damaged, and will never revert to normal oxidation, even in a dry air atmosphere. Furnaces should be thoroughly dried before the elements are installed, but if it is essential to use the elements for drying, then the furnace must be very well ventilated and no build up of steam must be allowed to occur. Glazed Kanthal Globar SD elements should always be specified where water vapor is likely, and for at least the first set of elements in brick lined or cast refractory lined furnaces, where some evolution of steam is inevitable during the first heating.

Kanthal Globar SD elements are also used successfully in neutral or reducing atmospheres, although a lower temperature limit is normally imposed.

In pure dry hydrogen for example, the maximum element temperature at which a useful life may be obtained is about 1200°C (2190°F). With lower percentages of hydrogen however, the maximum temperature may be raised and elements are successfully operated at temperatures of over 1300°C (2270°F) in commercial reducing atmospheres such as exothermic and endothermic gases. In pure nitrogen there is likely to be some reaction causing the formation of silicon nitride at furnace temperatures over 1300°C (2370°F). Pure oxygen atmosphere can be used, with only a slight increase in oxidation rate, but aluminum braid connections may react exothermically with the atmosphere, unless maintained in very good condition. The table below shows maximum suggested element temperature limits for various process gases.

Other process volatiles may also adversely affect element life by attacking either the silicon carbide or the protective silica coating. Alkali vapors, halogens, metal oxides and halides are particularly reactive and precautions must be taken to minimize any attack, by adequate ventilation of the furnace chamber, or by minimizing the transfer of aggres-

Maximum element temperature in various atmospheres

Atmosphere	Maximum element temperature		Comments
	°C	°F	
Clean dry air	1625	2950	1500°C (2730°F) for 3-piece construction
Pure oxygen	1500	2730	Faster oxidation than in air
Nitrogen	1350	2460	Forms silicon nitride at >1350°C (2460°F)
Dry hydrogen	1200	2190	Oxidizes in wet hydrogen
Dry exothermic gas	1400	2550	Very dependent on composition
Dry endothermic gas	1250	2280	Very dependent on composition
Vacuum	1200	2190	Generally for short term use only

sive media to the elements. Ventilation will also assist in preventing condensation of volatiles in the element location holes, where they may cause sticking and subsequent element breakage due to restriction. Although it is possible in most cases to reduce volatile attack to an acceptable level, it may be necessary in severe cases to sheathe the elements in suitable refractory or metallic tubes. The use of sheaths can result in a considerable increase in element temperature, particularly if ceramic sheath materials having relatively poor emissivity and thermal conductivity values are used, and it may be necessary to reduce the element loading to prevent overheating.

Where the atmosphere contains hydrocarbons, deposition of electrically conductive carbon can occur on the furnace walls, inside the pore structure of the refractories, and also on the elements themselves, causing tracking of the electrical supply. This problem can be minimized by strict control of the carbon potential of the gas, but it may be necessary to open the furnace to air periodically to burn off the carbon deposits. Note that carbon deposited in cooler areas of the furnace cannot be removed by this method, if the local temperature is insufficient to cause the carbon to burn.

Glazes and coatings

Special glazes and surface treatments have been developed which can extend element life in various operating conditions, particularly where chemical attack is a problem. Details of these will be provided on request.

Continuous or intermittent operation

Kanthal Globar SD heating elements are suitable for both continuous and intermittent operation, but at temperatures of 1400°C (2550°F) or above continuous operation is recommended for maximum service life. Volumetric changes, which rupture the protective silica coating if allowed to cool below about 900°C (1650°F), leave the silicon carbide exposed to further oxidation and consequent resistance increase. It is preferable to idle high temperature furnaces at about 900°C (1650°F) during short periods of non-production, where practical.

At temperatures below 1400°C (2550°F), the amount of silica formed is relatively small and the effect of cyclic operation will be minimal, especially if the cycle time is short. An economical element life may also be obtained under intermittent operation at temperatures above 1400°C (2550°F) but Kanthal Globar SG elements are normally recommended for these applications.

Power supplies

Kanthal Global SD elements can be considered as simple resistive loads and the normal electrical laws apply: i.e. where V = volts; I = amperes; W = watts; R = resistance in Ω

$$\begin{aligned}
 V &= IR = \sqrt{WR} = \frac{W}{I} \\
 W &= VI = I^2R = \frac{V^2}{R} \\
 I &= \frac{V}{R} = \sqrt{\frac{W}{R}} = \frac{W}{V} \\
 R &= \frac{V}{I} = \frac{V^2}{W} = \frac{W}{I^2}
 \end{aligned}$$

It is important to install, connect and control the elements in the recommended way, to ensure optimum life.

Element connections

Kanthal Global SD elements may be connected in parallel, series or combinations of the two.

Parallel connection is ideal, as any small variations in resistance value will tend to balance with use, whereas with series connection, the variation will tend to increase, resulting in a reduced element life.

As Kanthal Global SD elements increase in resistance fairly slowly however, the effect of any imbalance is small, and up to four elements may be connected in series, providing that they are well matched in resistance value. At furnace temperatures above 1400°C (2550°F) it is recommended that the number of series connected elements should be limited to two.

A series-parallel combination is usually an effective compromise, and in this case, the series groups should never be connected with parallel. Elements should never be connected with parallel groups connected in series, as failure of one element will result in overloading of the remaining elements in that group.

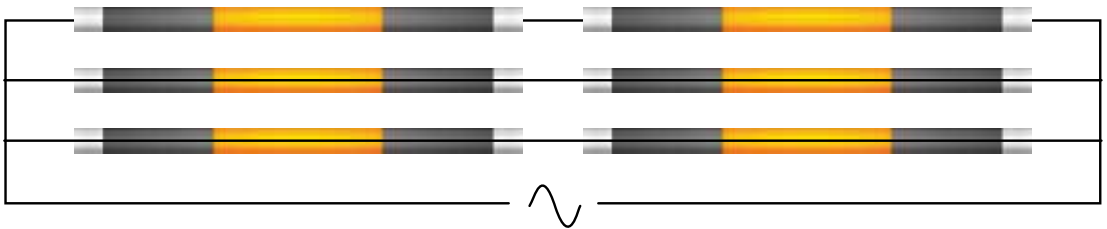

Preferred method of series/parallel connection

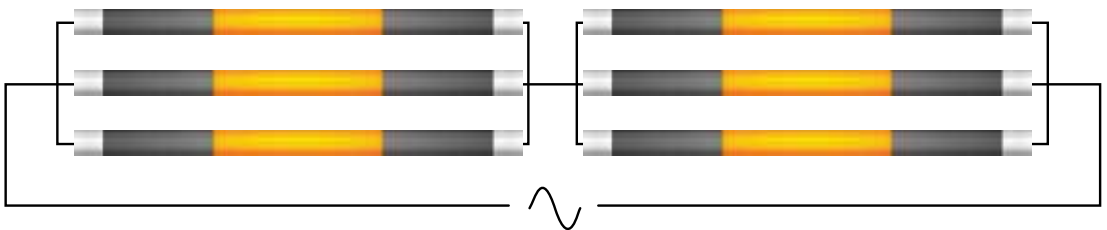

Alternative method of series/parallel connection, not recommended

Fig. 11 Series/parallel connection.

3-phase connections may include star (wye) or delta. Where a star connection is to be used, a 4-wire supply is recommended, to ensure that the phase voltages are balanced, irrespective of the phase resistances. If a 3-wire star connection must be used, then the phase resistances must always be closely matched.

Matching of resistance value

It is recommended that any series connected elements be selected within a resistance range of $\pm 5\%$ of each other, and elements connected in parallel may have a wider range of $\pm 10\%$.

If any element fails or is broken after only a short period in use it can usually be replaced with a new element; preferably one from the higher end of the resistance tolerance (low amp value). If the elements have been in use for a considerable time however, the entire group should be replaced otherwise an excessive load will fall on either the new or the old elements, resulting in premature failure.

It is good practice to divide the total number of elements in the furnace into relatively small control groups, to simplify matching at a later date. For example, a furnace fit with 48 elements, will be far more flexible if the elements are divided into 8 groups of 6 than with 3 groups of 16 elements, and matching of element resistances will be greatly simplified.

When a group of elements has been replaced, it is essential to ensure that the voltage output of the power supply equipment is reduced to the correct value before switching on, as overloading of elements, even for a very short period, can cause irreparable damage. The old elements may be retained for later use with others which have been in use for a similar period of time. If possible, voltage and current readings should be taken from each element before removal and the increased resistance value marked on the terminal to assist in matching at a later date.

It is important to note that the resistance values of elements at room temperature give no indication of their resistance at operating temperature and resistance measurements should always be taken at a constant temperature above 1000°C (1830°F).

Different types of heating elements should never be operated in the same electrical circuit, as variations in rates of resistance increase will cause overloading of one type or the other depending on the method of connection.

Voltage reserve

To compensate for the increase in element resistance which occurs with use, a variable voltage power supply is usually provided. The amount of voltage reserve required will depend upon the elements' rate of resistance increase and the life expected, but is usually in the order of 50–100% of the voltage required to give full power with new elements.

For example, if 125 V is required to give full power with new elements, then a voltage range of 125–250 V will be required to give 100% voltage reserve, and a range of 125–187.5 V to give 50% reserve.

Where elements are to be operating for long periods at temperatures of about 1400°C (2550°F) or above, or where the furnace conditions are such that an excessively high rate of resistance increase will occur at a lower temperature, then allowance should be made for 100% voltage reserve. Conversely, if the element temperature is very low, or the furnace only infrequently used, a voltage reserve of 50% or less may be found sufficient.

Power supply equipment

A variable voltage power supply is usually provided to enable the design power to be maintained throughout the life of the elements. The type of equipment used may have an effect on element performance and it is important that the correct selection procedures are adhered to if the best element life is to be obtained. Various types of power supply can be used:

1. Variable output transformer
2. Thyristor unit (SCR)
 - a. Phase-angle firing
 - b. Cycle-proportioning
3. Combined thyristor (SCR)/transformer system
4. Direct-on-line connection

Generally speaking, tapped transformers provide only on-off control, unless used in combination with thyristors. Although robust, and insensitive to short term overloading, the transformer is considered to be heavy, bulky and relatively expensive in most cases. Thyristor control offers a far more compact solution, with the option of step less variation of power, and 3-term, accurate temperature control, but will require an over-rated supply, and may cause disturbance in the supply lines. It is not usually practical to provide a voltage reserve of more than 50% using thyristor control alone, and where a large voltage reserve is required, in combination with 3-term control, the best, although most expensive, option is to combine the control benefits of the thyristor, with the large voltage span of a transformer.

Thyristor control alone is common in low temperature furnaces, laboratory furnaces, and other equipment where the rate of change of element resistance is likely to be low. For high temperature continuous industrial furnaces, where a large voltage reserve is required as well as accurate temperature control, then the additional costs of the combined transformer/thyristor system can usually be justified in terms of performance.

1 Variable output transformer

Infinitely variable transformers are occasionally used to power small laboratory and experimental units but are usually too expensive for larger furnaces, where multi-tapped transformers with stepped outputs are more economic. The maximum voltage step on a tapped transformer should never exceed 7% of the initial, full power voltage ($=\sqrt{WR}$), where W is the furnace design power and R is the network resistance based on the nominal resistance of the elements) and the element resistance tolerance must always be taken into account when calculating the maximum secondary current rating of the transformer ($=\sqrt{\frac{W}{R_{\min}}}$).

e.g. if a furnace is to be rated at 5 kW and fit with Kanthal Globar SD elements having a network resistance of $2\ \Omega$ ($\pm 15\%$) then the transformer specification might be calculated as follows:

$$\begin{aligned} \text{Nominal full power voltage} &= \\ &= \sqrt{WR} = \sqrt{5000 \times 2} = 100\ \text{V} \end{aligned}$$

$$\begin{aligned} \text{Voltage steps must not be greater than} \\ 7\% \text{ of } 100\ \text{V} &= 7\ \text{V} \end{aligned}$$

$$\begin{aligned} \text{Minimum network resistance} &= \\ &= 2\ \Omega - 15\% = 1.7\ \Omega \end{aligned}$$

$$\begin{aligned} \text{Maximum secondary current} &= \\ &= \sqrt{\frac{5000}{1.7}} = 54\ \text{A} \end{aligned}$$

$$\begin{aligned} \text{Minimum voltage required} &= \\ &= \sqrt{5000 \times 1.7} = 92\ \text{V} \end{aligned}$$

Assuming that 100% voltage reserve is required then the specification could be as follows:

Input: Single-phase, to suit supply

Output: Variable from 92 V to 197 V in 15 steps of 7 V (= 4 coarse \times 4 fine tappings)

Rating: 5 kVA from 92 V upwards (maximum secondary current 54 A)

(I) Where a tapped transformer is to be used then an allowance should be included in the furnace design power for the reduction in power output, which will occur between tap changes. With a 7% voltage step for example, the power will fall by about 12.5% before the voltage can be adjusted to the next setting.

(II) A few taps below 92 V may be included for lower powers if required.

(III) If an ammeter is to be used, then it should be installed in the primary circuit where the voltage is constant; the current reading will then give a true indication of the power dissipated by the elements, irrespective of the secondary voltage setting.

2 Thyristor (SCR) unit

A thyristor is a semi-conductor switching device which can control the average output to the elements by switching the mains supply on and off very rapidly. Each thyristor will conduct in only one direction and for control of a.c. loads the thyristors are installed in pairs, connected in inverse parallel. The thyristors are switched by a series of pulses fed from a suitable driver unit or temperature controller.

Thyristors can be simple devices, but are often provided with closed loop feedback, to compensate for variations in supply voltage, load characteristics, etc. Typical feedback modes include current control (I^2 feedback), voltage control (V^2 feedback) and true power control (VI feedback). In general, only V^2 feedback is suitable for use with silicon carbide elements, although there are some exceptions.

Current control tends to increase the power to the elements as they increase in resistance, and both power and current control can cause serious damage to the elements when starting from cold, when the element resistance is high. When presented with this high load resistance, both current and power control are likely to result in the application of maximum voltage to the elements, and if the available voltage is higher than the elements can withstand, then serious damage may occur. With voltage control, the delivery of power will be controlled by the resistance/temperature characteristics of the element, starting with a relatively low power, and gradually increasing as the elements heat up.

The output characteristics of the thyristor are governed by the firing method used and the two principal types are as follows:

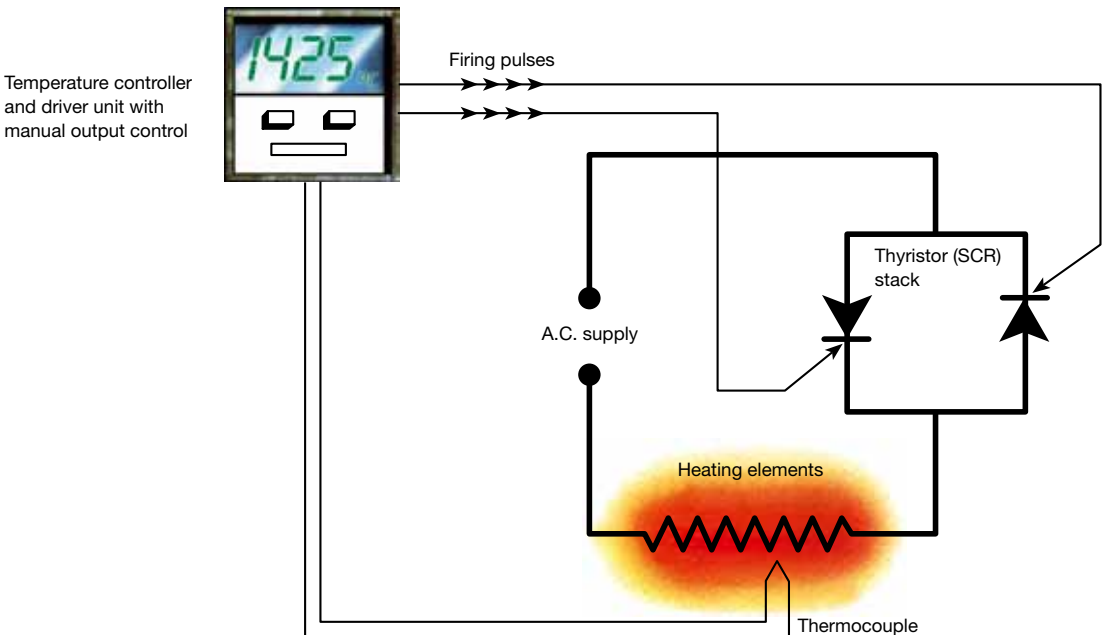

Fig. 12 Thyristor (SCR) unit.

2.1 Phase-angle firing

Each thyristor is triggered once in every half cycle of the a.c. supply, conduction ceasing at the end of the half cycle as the current falls to zero. In this way, the sinusoidal supply waveform is chopped, resulting in a reduction in the RMS output voltage of the thyristor stack. For control of silicon carbide elements, a manual voltage limit control must be provided to vary the conduction angle of the thyristors and thus compensate for resistance increase of the elements.

Phase-angle fired units may also be fit with a current limiting device, which may protect the thyristors from accidental overload, by preventing the current output from exceeding a pre-set value, irrespective of the voltage setting. This current limit must not be used to control the power input to the elements, as the power input ($= I^2R$) will gradually rise with increasing element resistance, resulting in progressive overloading of the elements, and possible damage when starting from cold.

As phase-angle fired thyristors give smooth, step less control of the applied voltage, they are ideally suited for use with silicon carbide elements. However, they can cause both radio frequency interference and supply waveform distortion, and consideration should be given to these factors when selecting the system to be used. The use of phase-angle firing is discouraged in many countries, or severely limited by local regulations.

As there is no current flow for part of the supply cycle, phase-angle controlled loads will give rise to an apparently poor power factor, even with a purely resistive load, and this can lead to problems on large installations, especially if the firing angle is small. Generally, the starting voltage with new elements should not be less than 60% of the supply voltage, to minimize this effect.

Supply cables must be rated at the RMS current drawn by the elements ($= \text{power} \div \text{thyristor output voltage}$ and *not* $\text{power} \div \text{supply voltage}$). This means that the power supply will be rated higher than the furnace design power, and the more voltage reserve is provided, the higher will be the required over-rating.

In 3-phase installations, generation of third harmonics will give rise to cumulative distortion of the supply waveform and may result in excessively high neutral currents of up to twice the line current in 3-phase, 4-wire, star-connected loads. Neutral cables must be adequately rated to carry this excess current. Although 3-wire star connection can be used to eliminate this problem, this can result in voltage imbalances between phases, especially where elements are not perfectly matched in resistance.

To minimize supply distortion in large installations, the use of a 6-wire, open-delta arrangement is recommended. The thyristors are required to carry

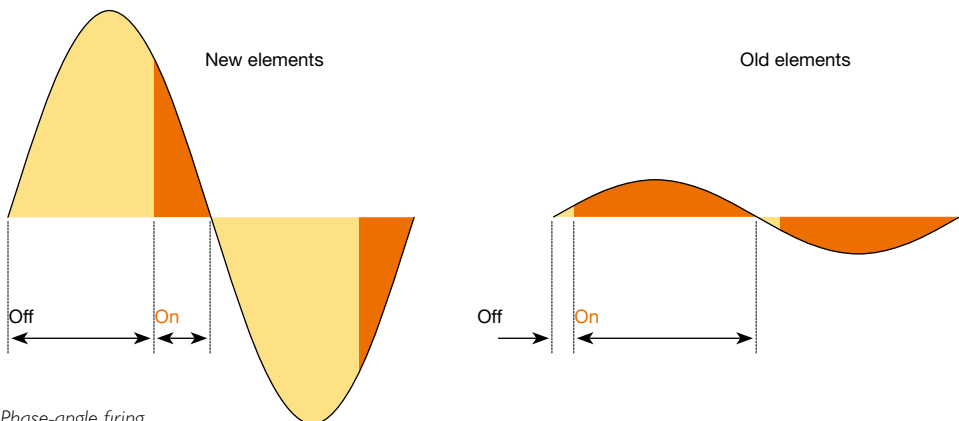
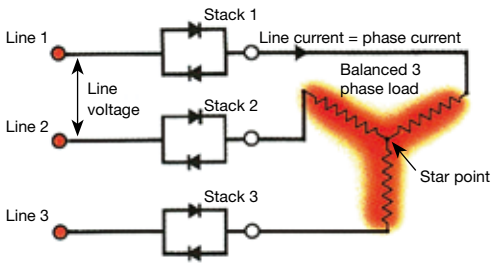

Fig. 13 Phase-angle firing.

only the phase current and not the line current as would be required in a closed delta installation, leading to a reduction in cost, and phases can be controlled independently, leading to more flexibility of control.

Calculation of the voltage output and current rating of phase-angle fired thyristor units is carried out in the same way as for a transformer, taking account of the element resistance tolerance when calculating the maximum current drawn.



3-phase, 3-wire, star-connection (phase-angle firing)
 Stack voltage rating = line voltage = phase voltage $\times \sqrt{3}$
 Stack current rating = line current = phase current
 Note: phase resistances and loads must be balanced

Fig. 14 Phase-angle firing: 3-wire star.

Power monitoring – phase-angle

Most voltmeters and ammeters will not indicate a true RMS reading from phase-angle controlled loads, and great care must be taken to ensure that the elements are not inadvertently overloaded. Some of the digital meters currently available will respond accurately to non-sinusoidal waveforms, but the manufacturer should be consulted to ensure that a suitable instrument is supplied. True RMS, hall-effect meters, with a crest factor of 7 or above, is recommended for an accurate response.

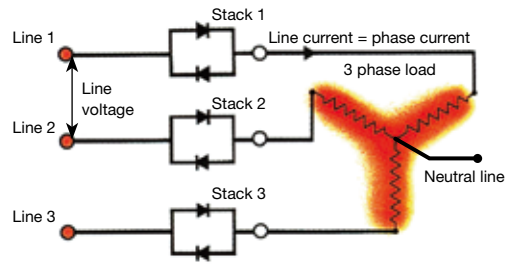

3-phase, 4-wire, star-connection (phase-angle firing)
 Stack voltage rating = phase voltage = $\frac{\text{line voltage}}{\sqrt{3}}$
 Stack current rating = line current = phase current
 Neutral cable rating = line current $\times 2$ for safety

Fig. 15 Phase-angle firing: 4-wire star.

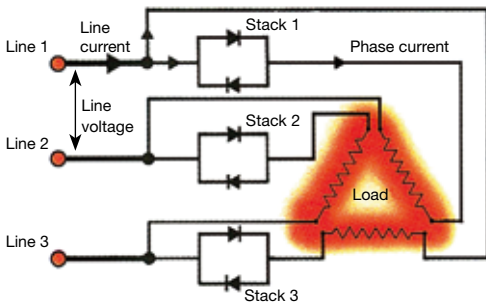

3-phase, open delta connection
 Stack voltage rating = line voltage
 Stack current rating = phase current ($= \frac{\text{line current}}{\sqrt{3}}$)

Fig. 16 Open delta: 6-wire.

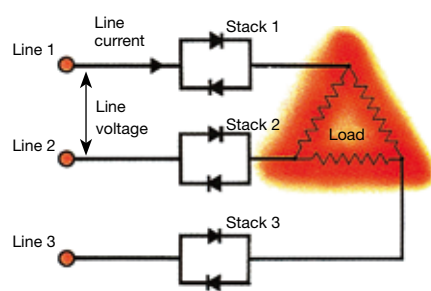

3-phase, closed delta connection
 Stack voltage rating = line voltage
 Stack current rating = line current = phase current $\times \sqrt{3}$

Fig. 17 Closed delta: 3-wire.

2.2 Fast-cycle firing

The thyristors are triggered at the beginning of a mains cycle and remain conductive for one or more complete cycles before being switched off for one or more cycles. This operation is continuously repeated, thus limiting the effective input to the elements. A manual control must be provided to vary the on/off ratio, and thus compensate for the gradual resistance increase of the elements.

Although the average power input to the elements may be within the normal recommended limits for start-up, temperature and atmosphere, each full cycle of the full mains voltage may cause loadings of several times this value to occur, and this can result in increased rates of resistance increase and premature, if not immediate, element failure. For this reason, it is necessary to connect the elements in such a way that the element loading during full cycles of the supply voltage does not exceed 15 W/cm^2 (97 W/in^2).

To minimize the effect of the 'on' burst, the time base of the firing cycle must be as short as possible and preferably less than 30 cycles of a 50Hz supply (i.e. 50% power = 15 cycles 'on' + 15 cycles 'off').

Slow-cycle thyristors generally have cycle times of several seconds and are not suitable for direct control

of silicon carbide elements. They may be used on the secondary side of tapped transformers however, in place of conventional electro-mechanical contactors.

The optimum type of burst-fired thyristor for use with silicon carbide elements is the single-cycle burst-firing type, where the required output is always reached over the minimum possible number of complete cycles (i.e. 50% power = 1 cycle 'on' + 1 cycle 'off').

The required voltage rating for the thyristors will be the same or higher than the supply voltage, but the current rating of the unit must be determined by dividing the RMS supply voltage by the minimum network resistance.

$$\text{i.e. } \frac{\text{current rating of thyristor}}{\text{of thyristor}} = \frac{\text{supply voltage}}{\text{minimum resistance}}$$

The rating of the thyristor will therefore be much higher than that of an equivalent phase-angle fired unit.

To calculate the required output from the thyristors, the power at the supply voltage must be calculated, and the on/off ratio of the thyristor limited to whatever percentage will provide the required design power.

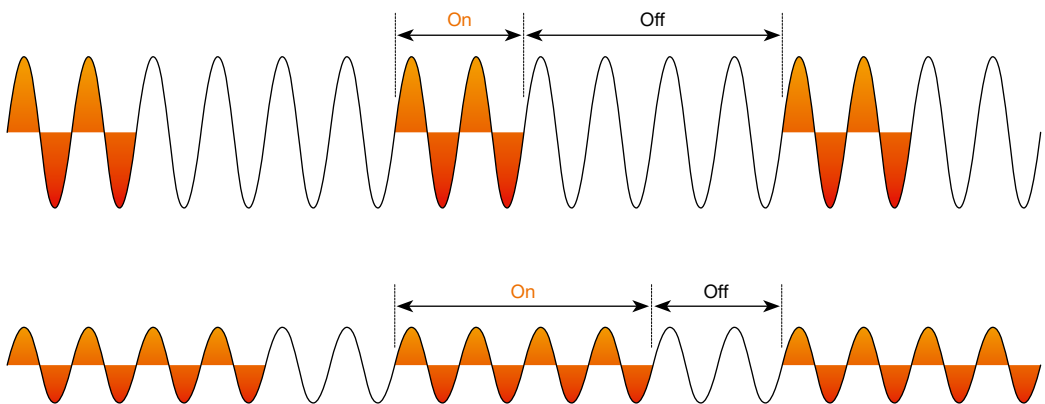

Fig. 18 Fast-cycle firing.

e.g. if the supply voltage is 200 V, and the resistance of the element network is 4 Ω, then the power at 200 V will be $\frac{200^2}{4} = 10000$ W. If the required power is 5 kW, then the thyristors must be set to give an output of $\frac{5000}{10000} = 50\%$

Resistive loads controlled by fast-cycle thyristors have a unity power factor and, as only full mains cycles are delivered to the load, there is no cumulative distortion of the mains supply. With heavy loads however, voltage drop may cause flickering lights and also affect sensitive equipment.

Power monitoring – fast-cycle

It is difficult to obtain voltmeters and ammeters which will respond accurately to fast-cycle controlled loads, and as most meters will indicate a reading considerably less than the actual thyristor output, great care must be taken to ensure that the elements are not inadvertently overloaded. The required output settings can be calculated, as above, based on the known resistance of the elements. If there is any doubt about the required setting, then the control should be set initially at a very low value and adjusted as required until sufficient power is available to raise the furnace to temperature. The control should be left at this setting until, due to resistance increase of the elements, insufficient power is available to maintain the furnace at temperature (or reach temperature if the furnace is in intermittent use). The control setting should then be increased slightly until sufficient power is again available.

3 Transformer + thyristor (SCR)

Due to the limitations imposed on the use of thyristor control, outlined in (A) and (B) it is sometimes not possible to provide an adequate voltage reserve, and it may be necessary to adopt a combined thyristor/tapped transformer power supply to ensure an adequate element life. Thyristors can be fit on either the primary or secondary side of the transformer, although precautions are especially required for primary connection. The transformers can be fit with only 2 or 3 tappings in most cases, as the intermediate steps can be accommodated by the thyristors. If the use of a combined system is being considered, then both transformer and

thyristor manufacturers should be informed at the design stage, to ensure compatibility of the equipment supplied. Kanthal can provide suggestions for the design of the equipment, on receipt of the element details, required power and temperature, and the local supply voltage.

4 Direct-on-line

Networks of elements may be connected directly to the mains voltage providing that the network resistance is sufficiently high to prevent element overloading. The network should be designed so that the initial power output is higher than the furnace rating to provide a power reserve and compensate for element resistance increase. Although the capital cost of a variable voltage supply is saved by this method, only a minimal power reserve can be provided, and in addition, a larger number of elements may be required in the furnace to dissipate the initial excess power.

It may be possible to gain an extra power reserve by modifying the element connections after the elements have aged (e.g. from 2 parallel branches of 3 elements in series to 3 parallel branches of 2 elements in series; or from 2 elements in series connected in delta to 2 elements in parallel connected in star). Because of its inherent drawbacks, direct-on-line connection is normally limited to relatively low temperature applications (under 1100°C (2010°F)) or infrequently used cyclic furnaces up to 1300°C (2370°F).

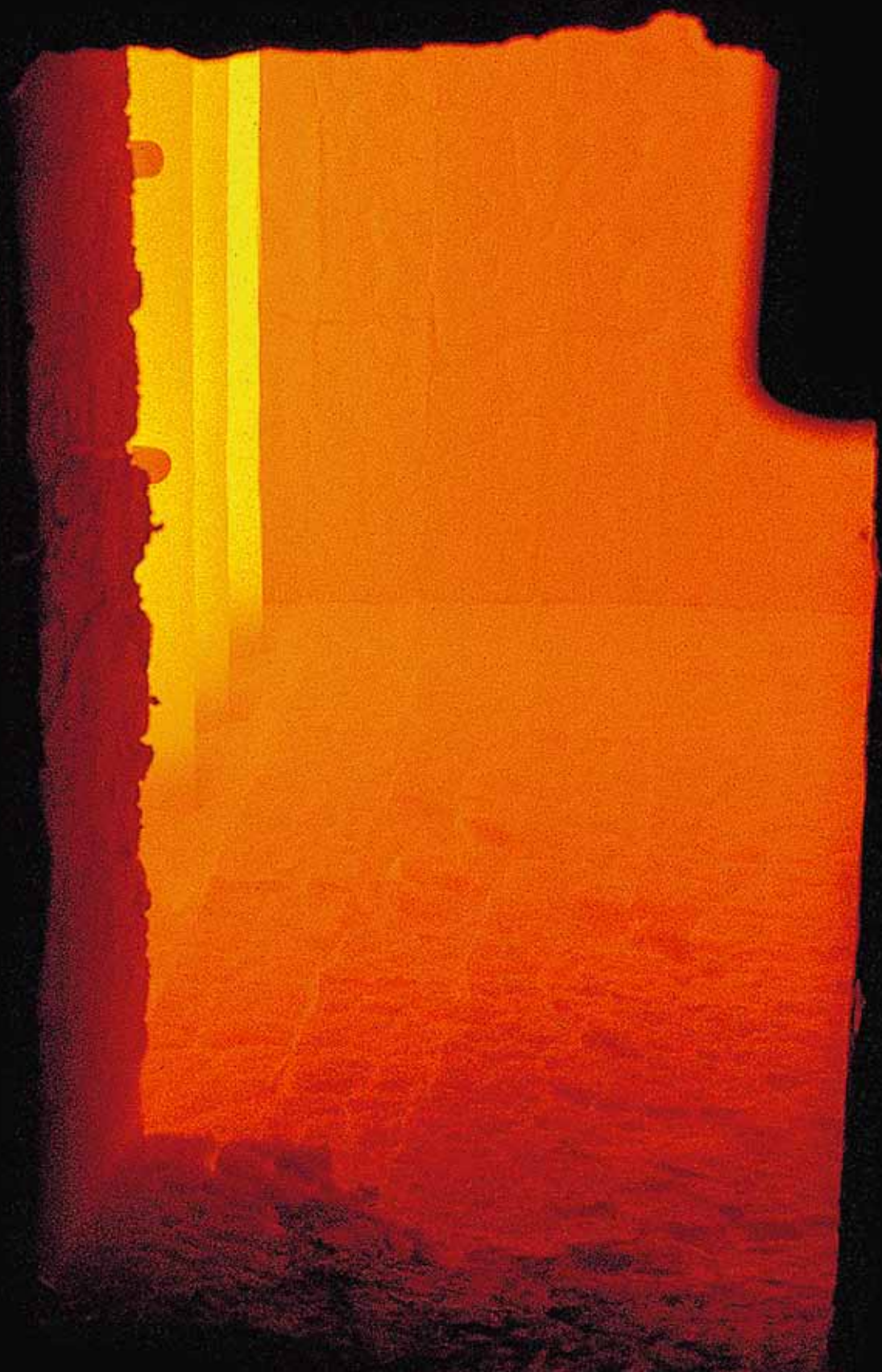

Ordering

The minimum information required when ordering Kanthal Globar SD elements is as follows:

Rod type elements

- Element type (Kanthal Globar SD)
- Diameter, mm ($\varnothing A$)
- Hot zone length, mm (B)
- Overall length, mm (L)
- Nominal resistance, Ω

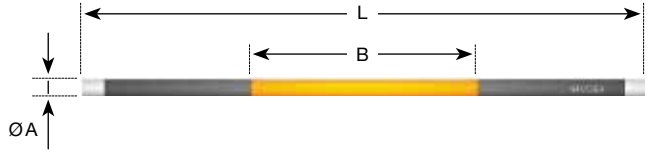

Multi-leg elements

- Element type (Kanthal Globar SD-U/CU/W)
- Diameter, mm ($\varnothing A$)
- Hot zone length, mm (B)
- Cold end length, mm (C)
- Leg center distance, mm (D)
- Slot position* (E)
- Nominal resistance, Ω

*Note: Standard slot position will be supplied unless specified otherwise (see Fig. 2).

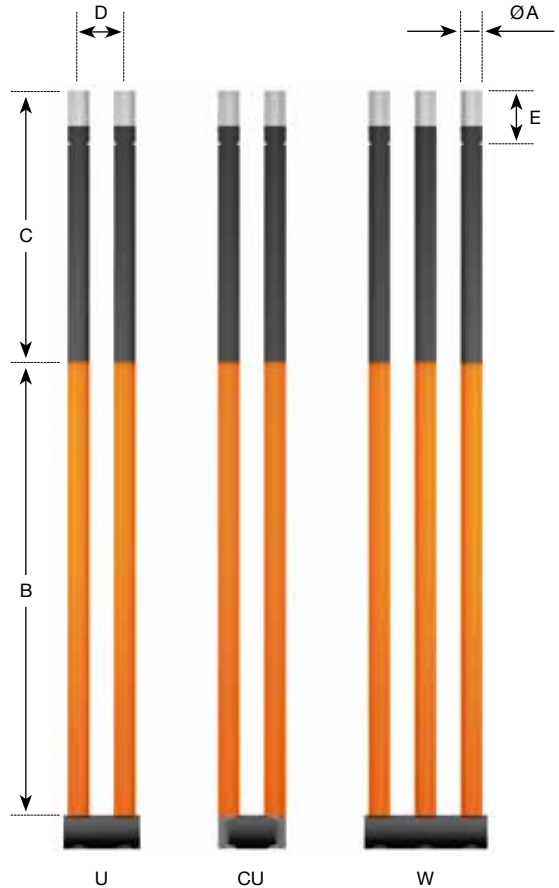

Accessories

Accessories available from Sandvik (full size list on request).



LB block



HC clip



CC clip



SL sleeve



G clamp



D clamp

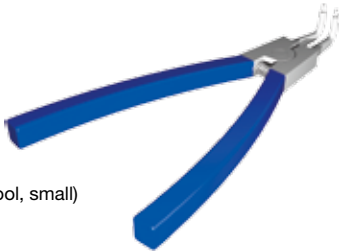

CT1 (clip-tool, small)



D1 braid



D2 braid

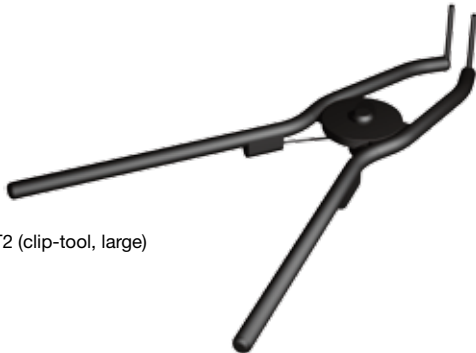

CT2 (clip-tool, large)



S1 braid



S2 braid

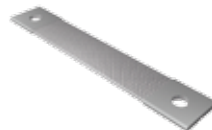

Q1 braid



Q2 braid

Sandvik Group

The Sandvik Group is a global high technology enterprise with 47,000 employees in 130 countries. Sandvik's operations are concentrated on three core businesses: Sandvik Tooling, Sandvik Mining and Construction and Sandvik Materials Technology – areas in which the group holds leading global positions in selected niches.

Sandvik Materials Technology

Sandvik Materials Technology is a world-leading manufacturer of high value-added products in advanced stainless steels and special alloys, and of medical implants, steel belt-based systems and industrial heating solutions.

Kanthal is a Sandvik owned brand, under which world class heating technology products and solutions are offered. Sandvik, Kanthal and Globar are trademarks owned by Sandvik Intellectual Property AB.

Quality management

Sandvik Materials Technology has quality management systems approved by internationally recognized organizations. We hold, for example, the ASME Quality Systems Certificate as a materials organization, approval to ISO 9001, ISO/TS 16949, ISO 17025, and PED 97/23/EC, as well as product approvals from TÜV, JIS and Lloyd's Register.

Environment, health and safety

Environmental awareness, health and safety are integral parts of our business and are at the forefront of all activities within our operation. We hold ISO 14001 and OHSAS 18001 approvals.

Disclaimer

Recommendations are for guidance only, and the suitability of a material for specific application can be confirmed only when we know the actual service conditions. Continuous development may necessitate changes in technical data without notice.

This printed matter is only valid for Sandvik material. Other material, covering the same international specifications, does not necessarily comply with the mechanical and corrosion properties presented in this printed matter.



Sandvik Materials Technology
Sandvik Heating Technology AB, Box 502, 734 27 Hallstahammar, Sweden Phone +46 220 21000 Fax +46 220 21166
www.kanthal.com www.smt.sandvik.com